



SCHIRTEC®

**LIGHTNING PROTECTION SYSTEMS
SURGE PROTECTION DEVICES
EARTHING MATERIALS**

2010



Created For Your Safety



ICMET



Staatliche Versuchsanstalt





EXTERNAL PROTECTION

SCHIRTEC E.S.E. LIGHTNING CONDUCTORS

SCHIRTEC E.S.E. Lightning Conductors are products that do not include radioactive materials but protect large fields from one point by becoming active with the lightning risk due to increasing atmospheric electrical field effect in lightning weathers. The head part of E.S.E. Lightning Conductors are formed by four main parts;

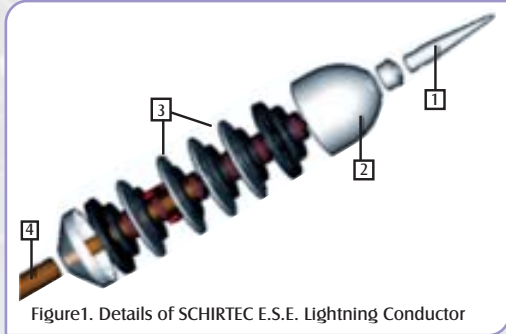

1. Air Terminal
2. Ion Generator
3. Accelerator and Atmospheric Electrodes
4. Grounding Connection Terminal

Figure1. Details of SCHIRTEC E.S.E. Lightning Conductor

The air terminal has enough size and quality to conduct the biggest lightning strike. Ion generator, induction coil and the protector have high impedance. The generator is located inside of a special epoxy resin. So, ion generator is protected from the environmental conditions.

Accelerator and atmospheric electrodes are designed in a way that can be charged with different potentials and with this feature, it is aimed to make work the electrodes as both additional ionization producing resource and as accelerator. The regulation is made with the number of the electrodes and ion generator's impedance, lets the different protection capacities in the SCHIRTEC E.S.E. Lightning Conductors.

Grounding connection terminal, makes the ground connection of the head. At the same time connection with the roof pole is provided with the pipe that the terminal exists.

The products of SCHIRTEC E.S.E. Lightning Conductors are produced with completely rustproof materials, and this feature is documented by TÜV certificate. Product's lightning current carrying capability is tested in BET Laboratory and CTI Vienna. Early ionization time and according to it early ionization way is documented by the tests made in ICMET laboratory.

The most important factor in SCHIRTEC E.S.E. Lightning Conductor is the protection radius. It depends on level calculation and the ΔT value, which is found in the product's test results.

The level of protection is calculated according to appendix B of the NF C 17-102.

The protection radius is calculated; $R_p = (h(2D-h) + \Delta L(2D + \Delta L))^{0.5}$ $h \geq 5m$Eq.1

h(m): True height of the Schirtec E.S.E. above the surface to be protected

D(m): Standardised striking distance D =20m (level I), 30m (level II), 45m (level III) or 60m (level IV)

ΔL (m): Triggering advance ΔT measured during efficiency tests acc. to appendix C of the NF C 17-102 standard which allows ΔT to be calculated using the formula $\Delta L = V \cdot \Delta T$, $V = 10^6$ m/s from NF C 17-102.

A sample calculation for SCHIRTEC-A:

If you calculate **Level-I** according to appendix B of the NF C 17-102

For **D=20 m**, $\Delta L=60$ m, $h=6m$,
from $R_p = (h(2D-h) + \Delta L(2D + \Delta L))^{0.5}$...Eq.1
Protection radius is **$R_p = 79$ m** calculated.

If you calculate **Level-III** according to appendix B of the NF C 17-102

For **D=45 m**, $\Delta L=60$ m, $h=6m$,
from Eq.1, **$R_p = 97$ m** calculated.

If you calculate **Level-II** according to appendix B of the NF C 17-102

For **D=30 m**, $\Delta L=60$ m, $h=6m$,
from Eq.1, **$R_p = 87$ m** calculated.

If you calculate **Level-IV** according to appendix B of the NF C 17-102

For **D=60 m**, $\Delta L=60$ m, $h=6m$
from Eq.1, **$R_p = 107$ m** calculated

SCHIRTEC-A E.S.E. LIGHTNING CONDUCTOR



The technical characteristic of its head is explained. This model was the first one presented to the world market.

SCHIRTEC-A E.S.E. LIGHTNING CONDUCTOR					
Ref.No:	Explanation	$\Delta T(\mu s)$	Material	Size (cm)	Weight(kg)
S-A	E.S.E. Type Lightning Conductor According to NF C 17-102 $\Delta T: 60 \mu s$	68	Stainless Steel	59x12	2,8



SCHIRTEC-AS E.S.E. LIGHTNING CONDUCTOR



The working principle of SCHIRTEC-AS Lightning Conductor's head is the same as that of the SCHIRTEC-A and SCHIRTEC-DA Lightning Conductors. By decreasing the number of the electrodes in the air terminal head and changing the ion generator impedance, SCHIRTEC-AS is provided with less protection capacity.

SCHIRTEC-AS E.S.E. LIGHTNING CONDUCTOR					
Ref.No:	Explanation	$\Delta T(\mu s)$	Material	Size (cm)	Weight(kg)
S-AS	E.S.E. Type Lightning Conductor According to NF C 17-102 $\Delta T:30 \mu s$	36	Stainless Steel	55x12	2,6

SCHIRTEC-DAS E.S.E. LIGHTNING CONDUCTOR



The technical characteristic of its head which is the same as the S-AS is explained on the above. The main difference between S-DAS and S-AS is the second ion generator .

With the help of this second ion generator, the SCHIRTEC-DAS has got a larger protection radius indeed.

SCHIRTEC-DAS E.S.E. LIGHTNING CONDUCTOR					
Ref.No:	Explanation	$\Delta T(\mu s)$	Material	Size (cm)	Weight(kg)
S-DAS	E.S.E. Type Lightning Conductor According to NF C 17-102 $\Delta T:45 \mu s$	45	Stainless Steel	66x12	3,8

SCHIRTEC-DA E.S.E. LIGHTNING CONDUCTOR



The technical characteristic of its head which is the same as the S-A is explained on the previous page. The main difference between S-DA and S-A is the second ion generator .

With the help of this second ion generator, the SCHIRTEC-DA has got a larger protection radius indeed.

SCHIRTEC-DA E.S.E. LIGHTNING CONDUCTOR					
Ref.No:	Explanation	$\Delta T(\mu s)$	Material	Size (cm)	Weight(kg)
S-DA	E.S.E. Type Lightning Conductor According to NF C 17-102 $\Delta T:60 \mu s$	75	Stainless Steel	70x12	4,1

The Protection Radius For SCHIRTEC E.S.E. Lightning Conductors (According to NF C 17-102)

Rp (m) h(m) Np	SCHIRTEC-AS ($\Delta T:30 \mu s$)				SCHIRTEC-DAS ($\Delta T:45 \mu s$)				SCHIRTEC-A/DA ($\Delta T:60 \mu s$)			
	I	II	III	IV	I	II	III	IV	I	II	III	IV
2	19	22	25	28	25	28	32	36	31	35	39	43
4	38	44	51	57	51	57	64	72	63	69	78	85
5	48	55	63	71	63	71	81	89	79	86	97	107
6	48	55	64	72	63	71	81	90	79	87	97	107
8	49	56	65	73	64	72	82	91	79	87	98	108
10	49	57	66	75	64	72	83	92	79	88	99	109
20	50	59	71	81	65	74	86	97	80	89	102	113
30	50	60	73	85	65	75	89	101	80	90	104	116
60	50	60	75	90	65	75	90	105	80	90	105	120



SCHIRTEC®

SCHIRTEC CERTIFICATES & TEST REPORTS

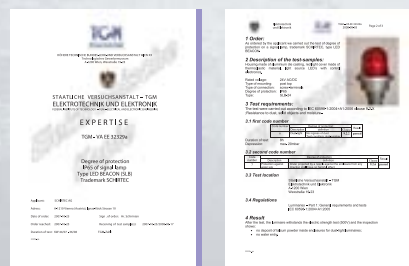
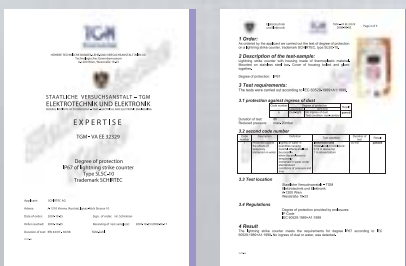
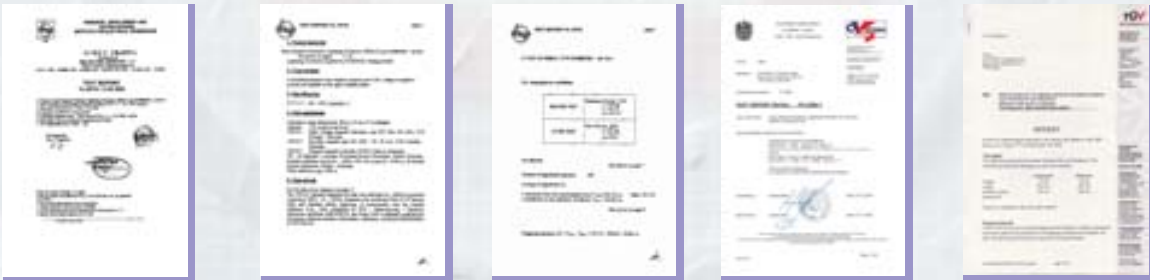



SCHIRTEC®

SA-1T (SCHIRTEC LIGHTNING CONDUCTOR TESTER)



The SCHIRTEC Lightning Conductors can be checked by this Tester every time. The Tester will indicate OK or FAULT with the help of red or green LED.

Ref.No:	Description	Dimension (cm)
SA-1T	SCHIRTEC Tester	6x9,5x3,8

SLSC-10 (SCHIRTEC LIGHTNING STRIKE COUNTER)



Ref.No:	Description
SLSC-10	SCHIRTEC Lightning Strike Counter

Description

The Lightning Strikes will be detected and recorded by SLSC-10. This functional device can show the intact operation of the Lightning System.

Why Should We Use Lightning Counter?

By using an inductive record, the counter is able accurately to count all lightning events for a later reference.

Operating Principle

SLSC-10 works with an inductive effect of the lightning strike current. The events are monitored by a mechanical counter display. The counter includes a high frequency transformer.

Applications and Descriptions

- ⊗ Currents detected from 2 to 100 kA
- ⊗ Nonresetable
- ⊗ Mechanical Counter with 6 digits
- ⊗ Easy mountable
- ⊗ Testable with 9V Battery
- ⊗ Does not require any external power supply
- ⊗ Produced according to IP 67 (certified by TGM Laboratory)
- ⊗ Serial Counter
- ⊗ Dimensions: 11,3x7x4,8 cm

VARIOUS LIGHTNING PROTECTION ACCESSORIES & EARTHING MATERIALS





SLB (SCHIRTEC LED BEACON)



Properties,

- ⊕ Special designed red glass cover.
- ⊕ Aluminium frame.
- ⊕ Anti-static protection covered circuit.
- ⊕ Produced according to IP 65 (certified by TGM Laboratory)

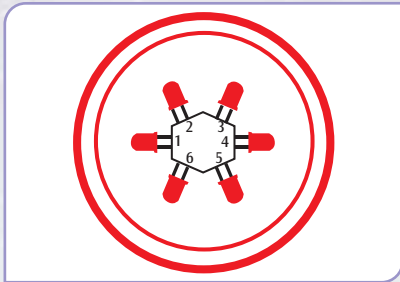

The SCHIRTEC LED BEACON is covered by a red colour glass and especially manufactured to show a maximum light distribution.

The SCHIRTEC LED BEACON's frame is manufactured by an injection aluminium technology. Upon it, a special kit is mounted in order to facilitate the montage.

For the security purpose, the red glass cover is connected with a slim steel wire (minimum 30 cm) to the aluminium frame firmly.

There is a microprocessor in the electronic circuit of this device which enable us to program the flashing periods.

As remarked in the above figure, there are 6 sets of LED placed in the device hexagonally. Each set consists of 8 pieces of LED totalled to 48 (6X8) pieces of LED. With the help of them, an efficient light distribution is possible for 360 degrees.

The inside micro controller checks all the LEDs permanently and tries to find out any failure. If any failure is located, the error LED should be lighted and the failure contact outputs will be activated.

The user is able to let this device function in 8 different modes. It is also possible to adjust every mode to fast or slow.

Characteristic of LED ;

This data shows some typical values.

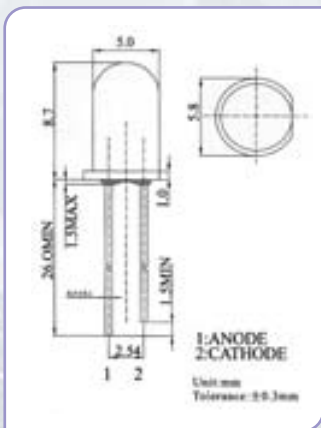

Directive Characteristics (Ta=25°C)

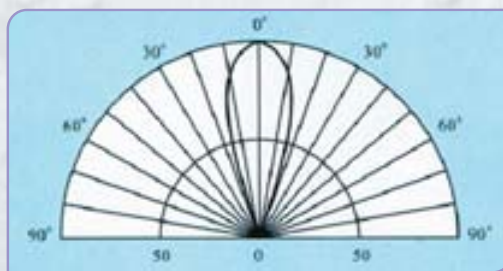

Relative Luminous Intensity (The view of 30 degrees)

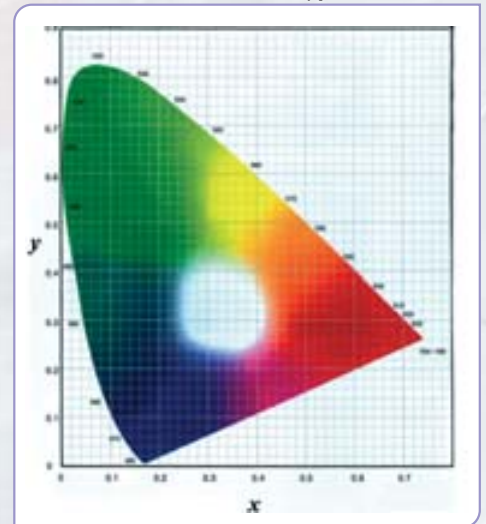

SCHIRTEC LED BEACON			
	SLB-24	SLB-48	SLB-220
Power Supply	24 V AC/ V DC	36-72 V AC/ V DC	220 V AC
Power Consumption	max. 3 W		
Luminescence (typical)	32 cd		
Luminescence (maximum)	46 cd		
Height & Diameter	206&135 mm		
Operating Temperature (°C)	- 40 to +85°C		
Weight	1,5 kg		



SCHIRTEC®

INTERNAL PROTECTION SURGE PROTECTION DEVICES

POWER SUPPLY SYSTEMS LIGHTNING ARRESTER CLASS I



- S45 = Encapsulated power spark gap $I_{imp} = 60\text{kA (L/N)}$, $U_N = 230\text{V/50Hz}$, $I_{max} = 100\text{ kA}$, $U_p \leq 2,5\text{ kV}$
- S50-50 = Encapsulated power spark gap $I_{imp} = 50\text{kA(L/N)}$, $U_N = 230\text{V/50Hz}$, $I_{max} = 110\text{ kA}$, $U_p \leq 1,3\text{ kV}$
- S55 = Encapsulated power spark gap $I_{imp} = 60\text{kA (L/N)}$, $U_N = 230\text{V/50Hz}$, $I_{max} = 100\text{ kA}$, $U_p \leq 4\text{ kV}$
- S50-3 = Encapsulated power spark gap $I_{imp} = 50\text{kA (L/N)}$, $U_N = 230\text{V/50Hz}$, $I_{max} = 110\text{ kA}$, $U_p \leq 1,3\text{ kV}$
- S100 = Encapsulated power spark gap $I_{imp} = 120\text{kA (N/PE)}$, $U_c = 255\text{V/50Hz}$, $I_{max} = 160\text{kA}$, $U_p \leq 2\text{ kV}$
- SB 120 = Lightning arrester class I. 85kA (8/20) , $U_N = 120\text{V}$, $I_{max} = 100\text{ kA}$, $U_p \leq 950\text{V}$
- SB 230 = Lightning arrester class I. 85kA (8/20) , $U_N = 230\text{V}$, $I_{max} = 100\text{ kA}$, $U_p \leq 1000\text{V}$
- SB 400 = Lightning arrester class I. 85kA (8/20) , $U_N = 400\text{V}$, $I_{max} = 100\text{ kA}$, $U_p \leq 1600\text{ V}$
- SB 500 = Lightning arrester class I. 85kA (8/20) , $U_N = 500\text{V}$, $I_{max} = 100\text{ kA}$, $U_p \leq 2100\text{ V}$
- SB 120S = Lightning arrester class I. $85\text{kA (8/20) + dist.sig.}$, $U_N = 120\text{V}$, $I_{max} = 100\text{ kA}$, $U_p \leq 950\text{V}$
- SB 230S = Lightning arrester class I. $85\text{kA (8/20) + dist.sig.}$, $U_N = 230\text{V}$, $I_{max} = 100\text{ kA}$, $U_p \leq 1000\text{V}$
- SB 400S = Lightning arrester class I. $85\text{kA (8/20) + dist.sig.}$, $U_N = 400\text{V}$, $I_{max} = 100\text{ kA}$, $U_p \leq 1600\text{ V}$
- SB 500S = Lightning arrester class I. $85\text{kA (8/20) + dist.sig.}$, $U_N = 500\text{V}$, $I_{max} = 100\text{ kA}$, $U_p \leq 2100\text{ V}$
- SBT 120 = Lightning arrester class I. 80kA (8/20) , $U_N = 120\text{ V}$, $I_{max} = 80\text{kA}$, $U_p \leq 1\text{kV}$
- SBT 230 = Lightning arrester class I. 80kA (8/20) , $U_N = 230\text{ V}$, $I_{max} = 80\text{ kA}$, $U_p \leq 2\text{kV}$
- SBT 400 = Lightning arrester class I. 80kA (8/20) , $U_N = 400\text{ V}$, $I_{max} = 80\text{kA}$, $U_p \leq 2\text{kV}$
- SBT 120S = Lightning arrester class I. $80\text{kA (8/20) + dist.sig.}$, $U_N = 120\text{V}$, $I_{max} = 80\text{kA}$, $U_p \leq 1\text{kV}$
- SBT 230S = Lightning arrester class I. $80\text{kA (8/20) + dist.sig.}$, $U_N = 230\text{V}$, $I_{max} = 80\text{ kA}$, $U_p \leq 2\text{kV}$
- SBT 400S = Lightning arrester class I. $80\text{kA (8/20) + dist.sig.}$, $U_N = 400\text{V}$, $I_{max} = 80\text{kA}$, $U_p \leq 2\text{kV}$
- SBN-80 = Encapsulated Gas Discharge Tube 80kA , $U_c = 255\text{V/50 Hz}$, $I_{max} = 120\text{ kA}$, $U_p \leq 1,3\text{ kV}$
- SBN-100 = Encapsulated Gas Discharge Tube 100kA , $U_c = 255\text{V/50Hz}$, $I_{max} = 150\text{kA}$, $U_p \leq 1,5\text{ kV}$
- SZ110 = Encapsulated power spark gap $I_{imp} = 110\text{ kA (L/N)}$, $U_N = 230\text{ V AC}$, $U_p \leq 2,5\text{ kV}$
- SZ110/500 = Encapsulated power spark gap $I_{imp} = 110\text{ kA (L/N)}$, $U_N = 400\text{ V AC}$, $U_p \leq 2,5\text{ kV}$
- SJK110 = Encapsulated power spark gap $I_{imp} = 110\text{ kA (N/PE)}$, $U_c = 255\text{ V AC}$, $I_{max} = 150\text{ kA}$, $U_p \leq 2\text{ kV}$



- SBM7-75 = Lightning arrester class I $I_{imp} = 7\text{ kA (10/350)}$, $U_c = 75\text{ V AC}$, $I_{max} = 50\text{ kA}$, $U_p < 350\text{ V}$
- SBM7-75S = Lightning arrester class I $I_{imp} = 7\text{ kA (10/350) dist. sig.}$, $U_c = 75\text{ V AC}$, $I_{max} = 50\text{ kA}$, $U_p < 350\text{ V}$
- SBM7-150 = Lightning arrester class I $I_{imp} = 7\text{ kA (10/350)}$, $U_c = 150\text{ V AC}$, $I_{max} = 50\text{ kA}$, $U_p < 950\text{ V}$
- SBM7-150S = Lightning arrester class I $I_{imp} = 7\text{ kA (10/350) dist. sig.}$, $U_c = 150\text{ V AC}$, $I_{max} = 50\text{ kA}$, $U_p < 950\text{ V}$
- SBM7-275 = Lightning arrester class I $I_{imp} = 7\text{ kA (10/350)}$, $U_c = 275\text{ V AC}$, $I_{max} = 50\text{ kA}$, $U_p < 1,2\text{ kV}$
- SBM7-275S = Lightning arrester class I $I_{imp} = 7\text{ kA (10/350) dist. sig.}$, $U_c = 275\text{ V AC}$, $I_{max} = 50\text{ kA}$, $U_p < 1,2\text{ kV}$
- SBM7-320 = Lightning arrester class I $I_{imp} = 7\text{ kA (10/350)}$, $U_c = 320\text{ V AC}$, $I_{max} = 50\text{ kA}$, $U_p < 1,3\text{ kV}$
- SBM7-320S = Lightning arrester class I $I_{imp} = 7\text{ kA (10/350) dist. sig.}$, $U_c = 320\text{ V AC}$, $I_{max} = 50\text{ kA}$, $U_p < 1,3\text{ kV}$



- SBM7-385 = Lightning arrester class I $I_{imp} = 7 \text{ kA (10/350)}$ $U_c = 385 \text{ V AC}$ $I_{max} = 50 \text{ kA}$ $U_p < 1,5 \text{ kV}$
- SBM7-385S = Lightning arrester class I $I_{imp} = 7 \text{ kA (10/350)}$ dist. sig. $U_c = 385 \text{ V AC}$ $I_{max} = 50 \text{ kA}$ $U_p < 1,5 \text{ kV}$
- SBM7-440 = Lightning arrester class I $I_{imp} = 7 \text{ kA (10/350)}$ $U_c = 440 \text{ V AC}$ $I_{max} = 50 \text{ kA}$ $U_p < 1,7 \text{ kV}$
- SBM7-440S = Lightning arrester class I $I_{imp} = 7 \text{ kA (10/350)}$ dist. sig. $U_c = 440 \text{ V AC}$ $I_{max} = 50 \text{ kA}$ $U_p < 1,7 \text{ kV}$
- SBM12,5-275 = Lightning arrester class I $I_{imp} = 12,5 \text{ kA (10/350)}$ $U_c = 275 \text{ V AC}$ $I_{max} = 100 \text{ kA}$ $U_p < 1,2 \text{ kV}$
- SBM12,5-275S = Lightning arrester class I $I_{imp} = 12,5 \text{ kA (10/350)}$ dist. sig. $U_c = 275 \text{ V AC}$ $I_{max} = 100 \text{ kA}$ $U_p < 1,2 \text{ kV}$
- SBM12,5-320 = Lightning arrester class I $I_{imp} = 12,5 \text{ kA (10/350)}$ $U_c = 320 \text{ V AC}$ $I_{max} = 100 \text{ kA}$ $U_p < 1,3 \text{ kV}$
- SBM12,5-320S = Lightning arrester class I $I_{imp} = 12,5 \text{ kA (10/350)}$ dist. sig. $U_c = 320 \text{ V AC}$ $I_{max} = 100 \text{ kA}$ $U_p < 1,3 \text{ kV}$
- SBM12,5-385 = Lightning arrester class I $I_{imp} = 12,5 \text{ kA (10/350)}$ $U_c = 385 \text{ V AC}$ $I_{max} = 100 \text{ kA}$ $U_p < 1,5 \text{ kV}$
- SBM12,5-385S = Lightning arrester class I $I_{imp} = 12,5 \text{ kA (10/350)}$ dist. sig. $U_c = 385 \text{ V AC}$ $I_{max} = 100 \text{ kA}$ $U_p < 1,5 \text{ kV}$
- SBM12,5-440 = Lightning arrester class I $I_{imp} = 12,5 \text{ kA (10/350)}$ $U_c = 440 \text{ V AC}$ $I_{max} = 100 \text{ kA}$ $U_p < 1,6 \text{ kV}$
- SBM12,5-440S = Lightning arrester class I $I_{imp} = 12,5 \text{ kA (10/350)}$ dist. sig. $U_c = 440 \text{ V AC}$ $I_{max} = 100 \text{ kA}$ $U_p < 1,6 \text{ kV}$
- SB25 = Encapsulated Gas Discharge Tube 25 kA $U_c = 255 \text{ V AC}$ $I_{max} = 50 \text{ kA}$ $U_p < 1,3 \text{ kV}$
- SB25M = Encapsulated Gas Discharge Tube 25 kA $U_c = 255 \text{ V AC}$ $I_{max} = 50 \text{ kA}$ $U_p < 1,3 \text{ kV}$

POWER SUPPLY SYSTEMS LIGHTNING ARRESTER CLASS I+II



- SSPC12,5 = 1 Pole Lightning arrester for TNC 12,5 kA (10/350)
- SSPC12,5S = 1 Pole Lightning arrester for TNC 12,5 kA (10/350) + dist.sig.
- SSPC12,5/1+1 = 1 Pole Lightning arrester for TNS or TT
Total Lightning Current 25 kA(10/350)
- SSPC12,5S/1+1S = 1 Pole Lightning arrester for TNS or TT
Total Lightning Current 25 kA(10/350) + dist.sig.
- SSPC12,5/3+0 = 3 Poles Lightning arrester for TNC 12,5 kA (10/350)
Total Lightning Current = 37,5 kA (10/350)
- SSPC12,5S/3+0 = 3 Poles Lightning arrester for TNC 12,5 kA (10/350) + dist.sig.
Total Lightning Current = 37,5 kA (10/350)
- SSPC12,5/3+1 = 3 Poles Lightning arrester for TNS or TT
Total Lightning Current 50 kA(10/350)
- SSPC12,5S/3+1 = 3 Poles Lightning arrester for TNS or TT
Total Lightning Current 50 kA(10/350) + dist.sig.
- SSPC25 = 1 Pole Lightning arrester for TNC 25 kA (10/350)
- SSPC25S = 1 Pole Lightning arrester for TNC 25 kA (10/350) + dist.sig.
- SSPC25/1+1 = 1 Pole Lightning arrester for TNS or TT
Total Lightning Current 50 kA(10/350)
- SSPC25S/1+1S = 1 Pole Lightning arrester for TNS or TT
Total Lightning Current 50 kA(10/350) + dist.sig.
- SSPC25/3+0 = 3 Poles Lightning arrester for TNC 12,5 kA (10/350)
Total Lightning Current = 75 kA (10/350)
- SSPC25S/3+0 = 3 Poles Lightning arrester for TNC 12,5 kA (10/350) + dist.sig.
Total Lightning Current = 75 kA (10/350)
- SSPC25/3+1 = 3 Poles Lightning arrester for TNS or TT
Total Lightning Current 100 kA(10/350)
- SSPC25S/3+1 = 3 Poles Lightning arrester for TNS or TT
Total Lightning Current 100 kA(10/350) + dist.sig.



POWER SUPPLY SYSTEMS LIGHTNING ARRESTER CLASS II



SCF-230



SC-230



SSPU1-240S



SSPU3-240S



SCN-20

- | | | | |
|-------------|-------------------------------------|----------------|--|
| SCF - 120 | = Surge arrester 20kA (8/20) | SC - 400 | = Surge arrester 15kA (8/20) |
| SCF - 230 | = Surge arrester 20kA (8/20) | SC- 120 S | = Surge arrester 15kA (8/20) + sig. |
| SCF - 280 | = Surge arrester 20kA (8/20) | SC - 230 S | = Surge arrester 20kA (8/20) + sig. |
| SCF - 400 | = Surge arrester 20kA (8/20) | SC - 280 S | = Surge arrester 20kA (8/20) + sig. |
| SCF - 120 S | = Surge arrester 20kA (8/20) + sig. | SC - 400 S | = Surge arrester 15kA (8/20) + sig. |
| SCF - 230 S | = Surge arrester 20kA (8/20) + sig. | SCN-20 | = Encapsulated Gas Discharge Tube 20kA,
$U_c=255V/50\text{ Hz}, I_{max}=20\text{ kA}, U_p \leq 1,3\text{ kV}$ |
| SCF - 280 S | = Surge arrester 20kA (8/20) + sig. | SSPU 1 - 120 | = 1 pole, U_N 120V |
| SCF - 400 S | = Surge arrester 20kA (8/20) + sig. | SSPU 3 - 240 S | = 3 poles, U_N 3x400/230V + sig. |
| SCT - 230 | = Surge arrester 15kA (8/20) | SSPU 1 - 240 S | = 1 pole, U_N 230V + sig. |
| SCT - 280 | = Surge arrester 15kA (8/20) | SSPU 1 - 240 | = 1 pole, U_N 230V |
| SCT - 230 S | = Surge arrester 15kA (8/20) + sig. | SSPU 3 - 240 | = 3 poles, U_N 3x400/230V |
| SCT - 280 S | = Surge arrester 15kA (8/20) + sig. | SSPU 3 - 120 | = 3 poles, U_N 3x208/120V |
| SC - 120 | = Surge arrester 15kA (8/20) | SSPU 3 - 400 | = 3 poles, U_N 3x680/400V |
| SC - 230 | = Surge arrester 20kA (8/20) | SPR 100 | = Helping Connection Module |
| SC - 280 | = Surge arrester 20kA (8/20) | | |

POWER SUPPLY SYSTEMS LIGHTNING ARRESTER CLASS III



SDL-32HFF



SDL-16HFF

SDL-25HFF



SDL-25HFFS



SD-16



SDI-16

- | | |
|----------------|--|
| SDLTN | = One phase protection for 230V |
| SDL-25RFIS | = Surge arrester 8kA (8/20), 230V, 25A + sig. |
| SDL-8HFF | = Surge arrester 8kA (8/20), 230V, 8A |
| SDL-16HFF | = Surge arrester 8kA (8/20), 230V, 16A |
| SDL-16HFFS | = Surge arrester 8kA (8/20), 230V, 16A + sig. |
| SDL-25HFF | = Surge arrester 8kA (8/20), 230V, 25A |
| SDL-25HFFS | = Surge arrester 8kA (8/20), 230V, 25A + sig. |
| SDL-25RFIS | = Surge arrester 8kA (8/20), 230V, 25A + sig. |
| SDL-32HFF | = Surge arrester 8kA (8/20), 230V, 32A |
| SDL-32HFFS | = Surge arrester 8kA (8/20), 230V, 32A + sig. |
| SDL-50HFF | = Surge arrester 8kA (8/20), 230V, 50A |
| SDL-63HFF | = Surge arrester 8kA (8/20), 230V, 63A |
| SDL-80HFF | = Surge arrester 8kA (8/20), 230V, 80A |
| SDL-120HFF | = Surge arrester 8kA (8/20), 230V, 120A |
| SDL-150HFF | = Surge arrester 8kA (8/20), 230V, 150A |
| SDL-16/400HFF | = Surge arrester 8kA (8/20), 400V, 16A |
| SDL-16/400HFFS | = Surge arrester 8kA (8/20), 400V, 16A + sig. |
| SDL- 316HFFS | = Surge arrester 8kA (8/20), 3x400/230V, 16A +sig |
| SDL- 325HFFS | = Surge arrester 8kA (8/20), 3x400/230V, 25A +sig |
| SDL- 332HFFS | = Surge arrester 8kA (8/20), 3x400/230V, 32A +sig |
| SDL- 350HFFS | = Surge arrester 8kA (8/20), 3x400/230V, 50A +sig |
| SDL- 363HFFS | = Surge arrester 8kA (8/20), 3x400/230V, 63A +sig |
| SDL- 380HFFS | = Surge arrester 8kA (8/20), 3x400/230V, 80A +sig |
| SDI- 16 | = Protected socket, 8kA (8/20), 16A |
| SD- 4 | = Protected socket with high freq. filter, 8kA (8/20), 6A |
| SD- 16 | = Protected socket with high freq. filter, 8kA (8/20), 16A |
| SD-FAXRJ12 | = Combined protection of suply and telephone network |



SCHIRTEC®

COMPUTER NETWORK PROTECTION



SD 2/100M - 5 cat
SD 4/100M - 5 cat



SD 4/100M - 5 cat



SD 2/100M - 5 cat

- SCHIRTECNET 8. RJ/RJ = Module for 8 stations, input and output RJ 45
- SCHIRTECNET 8.*XC/RJ = Module for 8 stations, input XC and output RJ 45
- SCHIRTECTEL 8.1 RJ/RJ = Module for 8 stations, input and output RJ 45
- SCHIRTECTEL 8.2 RJ/RJ = Module for 8 stations, input and output RJ 45
- SCHIRTECTEL 8.1 LSA/RJ = Module for 8 stations, input LSA-plus and output RJ 45
- SCHIRTECTEL 8.2 LSA/RJ = Module for 8 stations, input LSA-plus and output RJ 45

- SD 2/100M - 5 cat = Module for PC systems for 5 cat
- SD 1/100M - 5 cat = Module for PC systems for 5 cat
- SD 4/100M - 5 cat = Module for PC systems for 5 cat
- SCHIRTECNET 1. 2RJ/RJ = Module for PC systems for 5 cat
- SPSK 10 = Metal box
- SPSK 2/100M - 5 cat = Module for 2 pairs
- SPSK 4/100M - 5 cat = Module for 4 pairs
- SPSK 24 = Metal box

COAXIAL PROTECTION



SCO-1G
SCO-2G



SCO-1P
SCO-2P



SCO-10P



SCO-7/16

- SCO - 1P = for BNC connector
- SCO - 2P = for BNC connector
- SCO - 9P = for F connector
- SCO - 10P = TV connector
- SCO - 3GN (F/F) = for N connector
- SCO - 3GN (F/M) = for N connector
- SCO - 4GN (F/F) = for N connector
- SCO - 4GN (F/M) = for N connector
- SCO-1G = for BNC connector
- SCO-2G = for BNC connector
- SCO-9G = for F connector
- SCO-10G = TV connector
- SCO-11G = for UHF connector
- SCO-12G = for UHF connector
- SCO-7/16 = 7/16 connector (F/F)

INSULATION LEVEL DROP DETECTOR



SIS-71



CE-500

- SIS 71 = Ins. level drop detector AC IT system (10-210kW)
- SIS 72 = Ins. level drop detector AC IT system (1-9kW)
- CE 500 = Inductor 3x500V

EQUIPOTENTIAL BONDING (HIGH POWER GAS DISCHARGE TUBE)



SGDT-100-RW



SGDT-100

- SGDT-150-RW1
- SGDT-150-RW2
- (Isolating Spark Gap for Railway systems, $I_{imp} = 150 \text{ kA}$)
- SGDT-100 = Isolating Spark Gap, $I_{imp} = 100 \text{ kA}$
- SGDT-100-Ex = Ex Isolating Spark Gap, $I_{imp} = 100 \text{ kA}$
- SGDT-100-RW = Ex Isolating Spark Gap, $I_{imp} = 100 \text{ kA}$

SURGE PROTECTION SYSTEMS

Home and Office Application

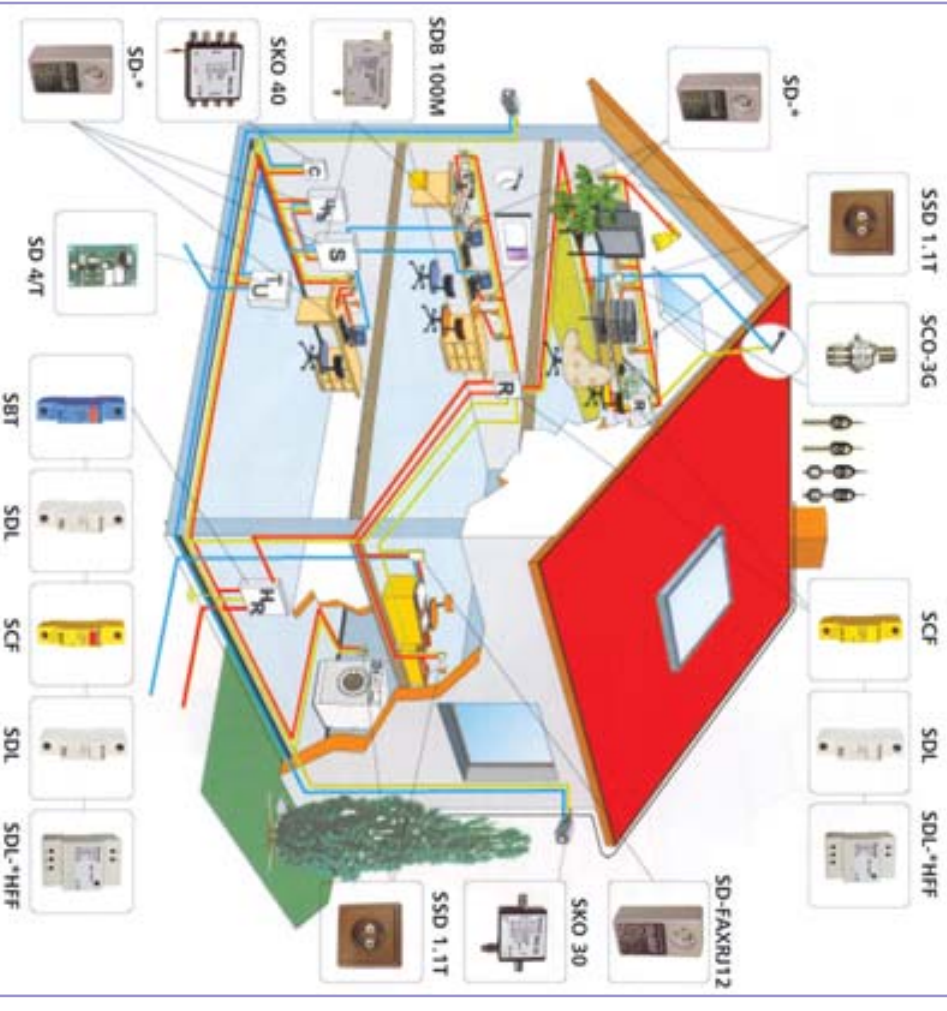

HR - Main switchboard
R - Subdistribution switchboard

TU - Tel. central
C - Security central
S - Server computer



E.S.E. LIGHTNING CONDUCTORS INSTALLATION SCHEME



www.schirtec.at



SCHIRTEC®



ICMET



TUV tgm



SCHIRTEC®

2010



Created For Your Safety



ICMET



BLITZSCHUTZ & EMV TECHNOLOGIEZENTRUM



Staatliche Versuchsanstalt



SCHIRTEC AG

IGNAZ-KÖCK STRASSE 10
1210 WIEN / AUSTRIA

PHONE: +43 1 27574 1601 +43 1 27574 1602

FAX: +43 1 27574 1610

www.schirtec.at e-mail: info@schirtec.at